



# CRANE ROPE

WUXI METALLINK

# Contents

---

## **3 Ordinary crane rope**

Class 6×36  
Class 6×K36  
Class 8×19  
Class 8×K19

## **9 Rotation-resistant crane rope**

15×K7-IWRC  
Class 18×7  
Class 18×K7  
24×K7  
35(W)×7 & 24(W)×7  
35(W)×K7

## **17 shaped strand crane rope**

4×V39FC-FC

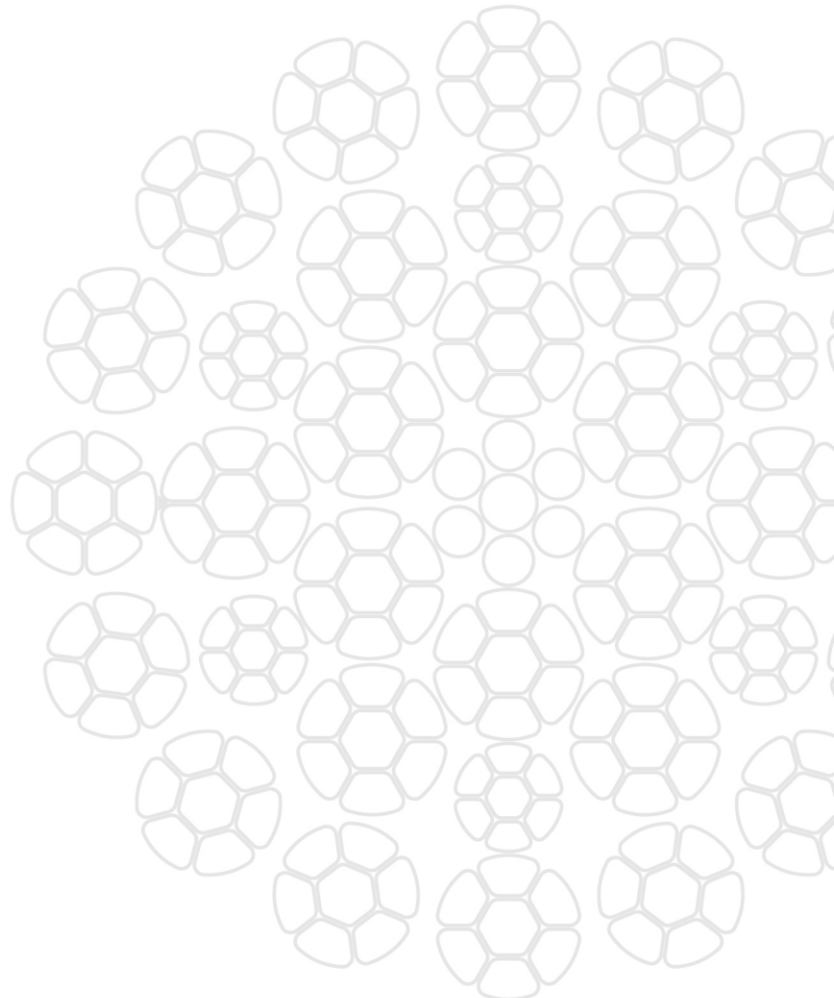

# Ordinary crane rope

## Round strand

### Application

Tower crane, crawler crane, mobile crane, port crane etc.

Rope $\varnothing$	Approx. length mass	MBL (1770)	MBL (1960)	MBL (2160)
mm	kg/100m	kN	kN	kN
8	24.3	37.4	41.4	45.6
9	30.8	47.3	52.4	57.7
10	38.0	58.4	64.7	71.3
11	46.0	70.7	78.3	86.2
12	54.7	84.1	93.1	103
13	64.2	98.7	109	120
14	74.5	114	127	140
16	97.3	150	166	182
18	123	189	210	231
20	152	234	259	285
22	184	283	313	345
24	219	336	373	411
26	257	395	437	482
28	298	458	507	559
30	342	526	582	642
32	389	598	662	730
36	492	757	838	924
40	608	935	1030	1140
44	736	1130	1250	1380
48	876	1350	1490	1640
52	1030	1580	1750	1930
56	1190	1830	2030	2240
60	1370	2100	2330	2570

\* Standard GB/T 20118, ISO 2408 is available upon request

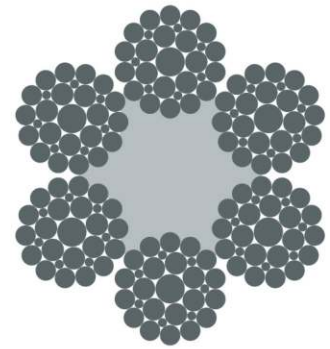

6×29F-FC

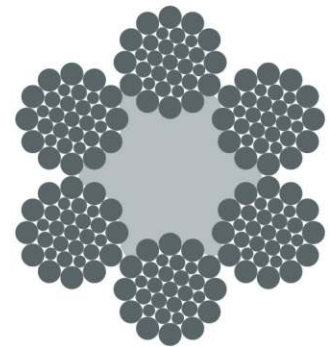

6×31WS-FC

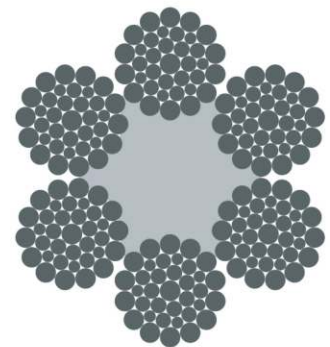

6×36WS-FC

# Ordinary crane rope

## Round strand

### Application

Tower crane, crawler crane, mobile crane, port crane etc.

Rope $\varnothing$	Approx. length mass	MBL (1770)	MBL (1960)	MBL (2160)
mm	kg/100m	kN	kN	kN
8	26.8	40.3	44.7	49.2
9	33.9	51.0	56.5	62.3
10	41.8	63.0	69.8	76.9
11	50.6	76.2	84.4	93.0
12	60.2	90.7	100	111
13	70.6	106	118	130
14	81.9	124	137	151
16	107	161	179	197
18	135	204	226	249
20	167	252	279	308
22	202	305	338	372
24	241	363	402	443
26	283	426	472	520
28	328	494	547	603
30	376	567	628	692
32	428	645	715	787
36	542	817	904	997
40	669	1010	1120	1230
44	809	1220	1350	1490
48	963	1450	1610	1770
52	1130	1700	1890	2080
56	1310	1980	2190	2410
60	1500	2270	2510	2770

\* Standard GB/T 20118, ISO 2408 is available upon request

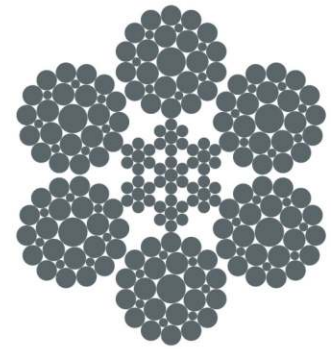

6×29F-IWRC

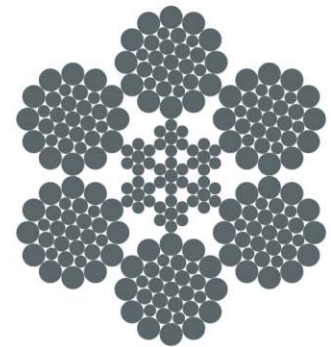

6×31WS-IWRC

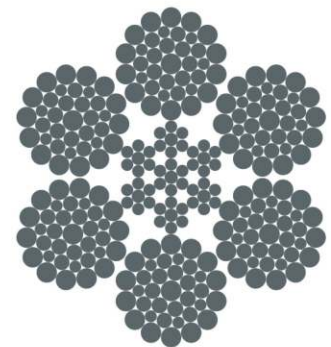

6×36WS-IWRC

# Ordinary crane rope

## Compacted strand

### Application

Tower crane, crawler crane, mobile crane, port crane etc.

Rope $\varnothing$	Approx. length mass	MBL (1770)	MBL (1960)	MBL (2160)
mm	kg/100m	kN	kN	kN
10	42.5	66.0	73.1	80.6
12	61.2	95.1	105	116
14	83.3	129	143	158
16	109	169	187	206
18	138	214	237	261
20	170	264	292	322
22	206	320	354	390
24	245	380	421	464
26	287	446	494	545
28	333	518	573	632
30	383	594	658	725
32	435	676	749	825
34	491	763	845	931
36	551	856	947	1040
38	614	953	1060	1160
40	680	1060	1170	1290
42	750	1160	1290	1420
44	823	1280	1420	1560
46	899	1400	1550	1700
48	979	1520	1680	1860
50	1060	1650	1830	2010
52	1150	1790	1980	2180
54	1240	1930	2130	2350
56	1330	2070	2290	2530
58	1430	2220	2460	2710
60	1530	2380	2630	2900

\* Standard YB/T 5359, ISO 2408 is available upon request

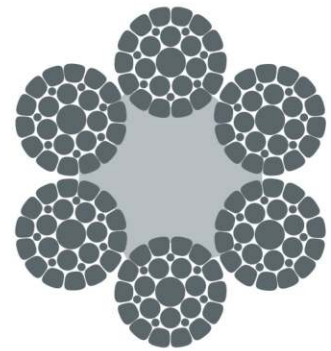

6×K29F-FC

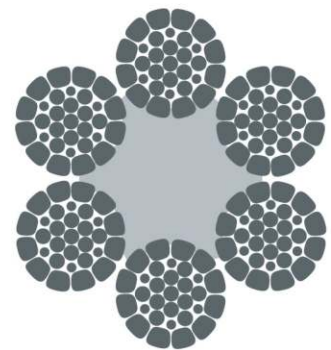

6×K31WS-FC

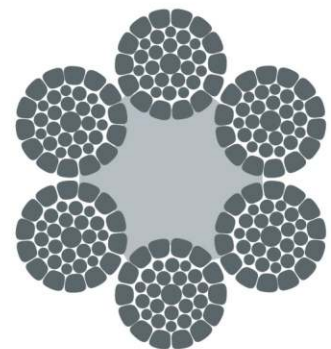

6×K36WS-FC

# Ordinary crane rope

## Compacted strand

### Application

Tower crane, crawler crane, mobile crane, port crane etc.

Rope $\varnothing$	Approx. length mass	MBL (1770)	MBL (1960)	MBL (2160)
mm	kg/100m	kN	kN	kN
10	46.5	73.5	81.3	89.6
12	67.0	106	117	129
14	91.1	144	159	176
16	119	188	208	229
18	151	238	264	290
20	186	294	325	359
22	225	356	394	434
24	268	423	469	516
26	314	497	550	606
28	365	576	638	703
30	419	661	732	807
32	476	752	833	918
34	538	849	940	1040
36	603	952	1050	1160
38	671	1060	1170	1290
40	744	1180	1300	1430
42	820	1300	1430	1580
44	900	1420	1570	1740
46	984	1550	1720	1900
48	1070	1690	1870	2070
50	1160	1840	2030	2240
52	1260	1990	2200	2420
54	1360	2140	2370	2610
56	1460	2300	2550	2810
58	1560	2470	2740	3020
60	1670	2640	2930	3230

\* Standard YB/T 5359, ISO 2408 is available upon request

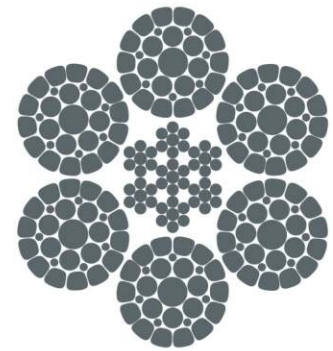

6×K29F-IWRC

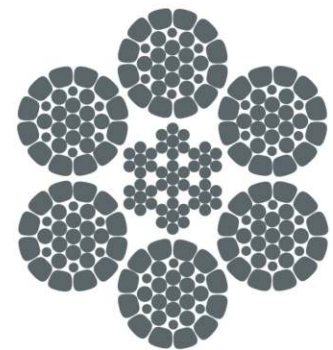

6×K31WS-IWRC

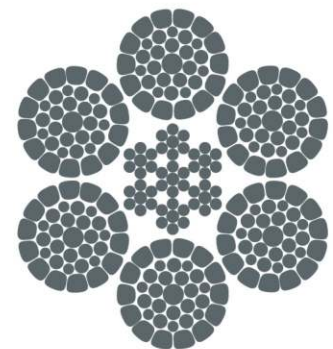

6×K36WS-IWRC

# Ordinary crane rope

## Round strand

### Application

Tower crane, crawler crane, mobile crane, port crane etc.

Rope $\varnothing$	Approx. length mass	MBL (1770)	MBL (1960)	MBL (2160)
mm	kg/100m	kN	kN	kN
8	27.8	39.2	43.4	47.8
9	35.2	49.6	54.9	60.5
9.53	39.5	55.6	61.6	67.9
10	43.5	61.2	67.8	74.7
11	52.6	74.1	82.1	90.4
12	62.6	88.2	97.7	108
12.7	70.2	99	109	121
13	73.5	103	115	126
14	85.3	120	133	146
15.9	110	155	171	189
16	111	157	174	191
18	141	198	220	242
19	157	221	245	270
20	174	245	271	299
22	211	296	328	362
24	251	353	391	430
26	294	414	458	505
28	341	480	532	586
30	392	551	610	673
32	445	627	694	765
36	564	794	879	969
40	696	980	1090	1200

\* Standard GB/T 20118, ISO 2408 is available upon request

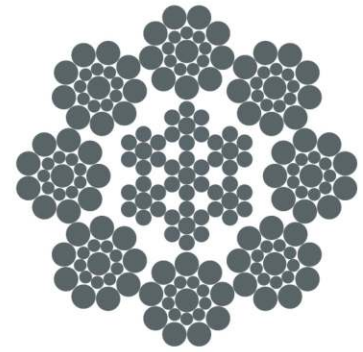

8×19S-IWRC

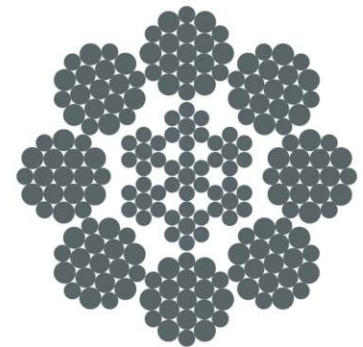

8×19W-IWRC

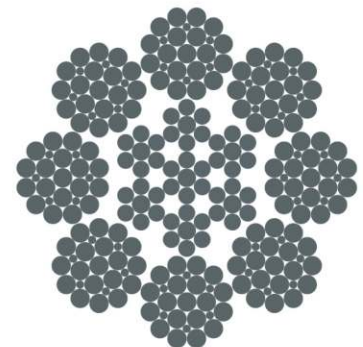

8×25F-IWRC

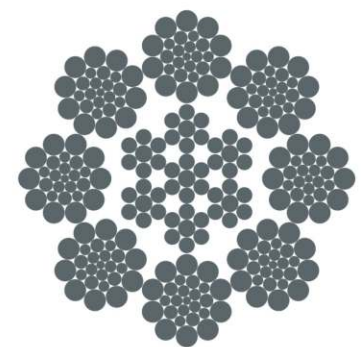

8×26WS-IWRC

# Ordinary crane rope

## Compacted strand

### Application

Tower crane, crawler crane, mobile crane, port crane etc.

Rope $\varnothing$	Approx. length mass	MBL (1770)	MBL (1960)	MBL (2160)
mm	kg/100m	kN	kN	kN
8	31.0	47.0	52.1	57.4
9	39.3	59.5	65.9	72.6
9.53	44.0	66.7	73.9	81.4
10	48.5	73.5	81.3	89.6
11	58.7	88.9	98.4	108
12	69.8	106	117	129
12.7	78.2	118	131	145
13	82.0	124	137	151
14	95.1	144	159	176
15.9	123	186	206	227
16	124	188	208	229
18	157	238	264	290
19	175	265	294	324
20	194	294	325	359
22	235	356	394	434
24	279	423	469	516
26	328	497	550	606
28	380	576	638	703
30	437	661	732	807
32	497	752	833	918
36	629	952	1050	1160
40	776	1180	1300	1430

\* Standard YB/T 5359, ISO 2408 is available upon request

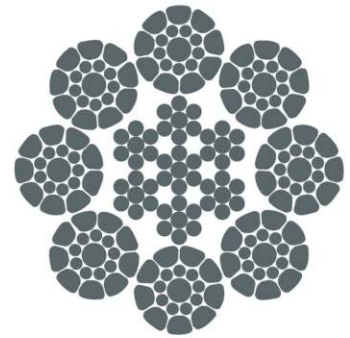

8×K19S-IWRC(7x7)

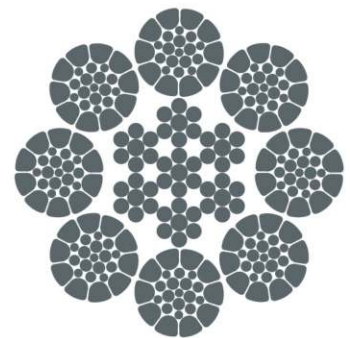

8×K26WS-IWRC(7x7)

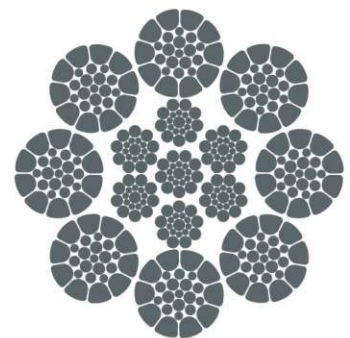

8×K26WS-IWRC(7x19S)

# Ordinary crane rope

## Compacted strand

### Application

Tower crane, crawler crane, mobile crane.

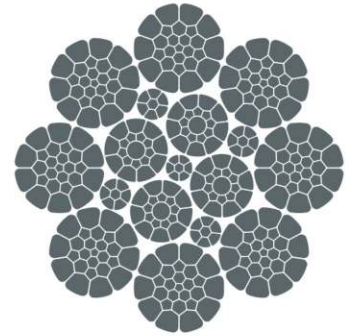

8×K26WS-PWRC(K)

Rope ø	Approx. length mass	MBL (1770)	MBL (1960)	MBL (2160)
mm	kg/100m	kN	kN	kN
12	75.3	124	137	151
13	88.4	145	161	177
14	103	169	187	206
15	118	194	214	236
16	134	220	244	269
17	151	249	275	303
18	169	279	309	340
19	189	311	344	379
20	209	344	381	420
21	231	379	420	463
22	253	416	461	508
23	277	455	504	555
24	301	495	549	605
25	327	538	595	656
26	354	582	644	710
27	381	627	694	765
28	410	674	747	823
29	440	723	801	883
30	471	774	857	945
32	536	881	975	1070
34	605	994	1100	1210
36	678	1110	1230	1360
38	755	1240	1380	1520
40	837	1380	1520	1680

\* Standard YB/T 5359

# Rotation-resistant rope

## Compacted strand

### Application

Main hoist ropes for tower crane, crawler crane, mobile crane

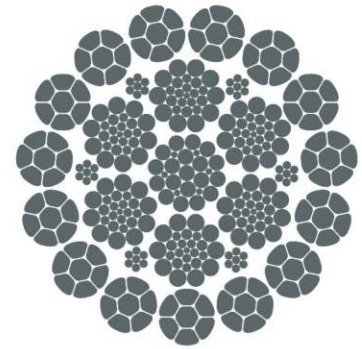

15×K7-IWRC

Rope ø	Approx. length mass	MBL (1770)	MBL (1960)	MBL (2160)
mm	kg/100m	kN	kN	kN
12	69.1	105	116	128
13	81.1	123	136	150
14	94.1	142	158	174
16	123	186	206	227
18	156	235	260	287
20	192	290	321	354
22	232	351	389	429
24	276	418	463	510
26	324	491	543	599
28	376	569	630	694
30	432	653	723	797
32	492	743	823	907
36	622	941	1040	1150
40	768	1160	1290	1420
44	929	1400	1560	1710
48	1110	1670	1850	2040
52	1300	1960	2170	2390
56	1510	2280	2520	2780
60	1730	2610	2890	3190

\* Standard YB/T 5359, ISO 2408 is available upon request

# Rotation-resistant rope

## Round strand

### Application

Main hoist ropes for tower crane, crawler crane, mobile crane

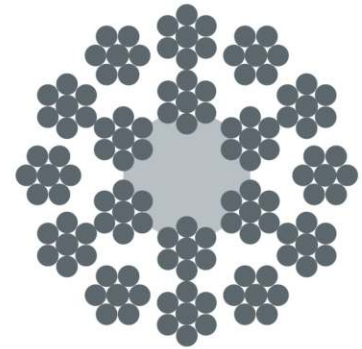

18×7-FC

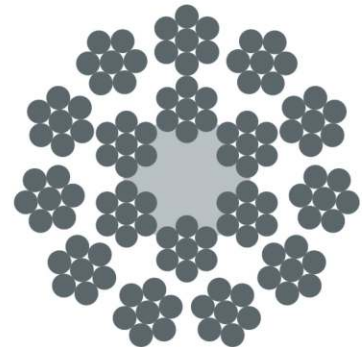

17×7-FC

Rope $\varnothing$	Approx. length mass	MBL (1770)	MBL (1960)	MBL (2160)
mm	kg/100m	kN	kN	kN
6	14.0	19.8	21.9	24.1
7	19.1	26.9	29.8	32.8
8	25.0	35.1	38.9	42.9
9	31.6	44.4	49.2	54.2
10	39.0	54.9	60.8	67.0
11	47.2	66.4	73.5	81.0
12	56.2	79.0	87.5	96
13	65.9	92.7	103	113
14	76.4	108	119	131
16	100	140	156	171
18	126	178	197	217
20	156	219	243	268
22	189	266	294	324
24	225	316	350	386
26	264	371	411	453
28	306	430	476	525
30	351	494	547	603
32	399	562	622	686
36	505	711	787	868
40	624	878	970	1070
44	755	1060	1180	1300
48	899	1260	1400	1540
52	1050	1480	1640	1810
56	1220	1720	1910	2100
60	1400	1980	2190	2410

\* Standard GB/T 20118, ISO 2408 is available upon request

# Rotation-resistant rope

## Round strand

### Application

Main hoist ropes for tower crane, crawler crane, mobile crane

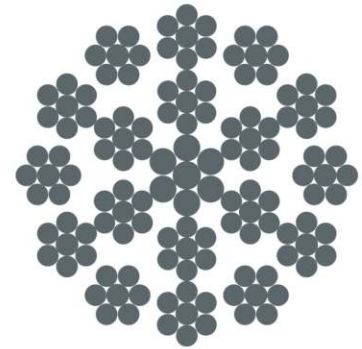

18×7-WSC

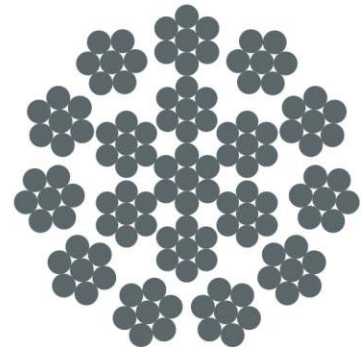

17×7-WSC

Rope $\varnothing$	Approx. length mass	MBL (1770)	MBL (1960)	MBL (2160)
mm	kg/100m	kN	kN	kN
6	15.5	20.9	23.1	25.5
7	21.1	28.4	31.5	34.7
8	27.5	37.2	41.1	45.3
9	34.8	47.0	52.1	57.4
10	43.0	58.1	64.3	70.8
11	52.0	70.2	77.8	85.7
12	61.9	83.6	92.6	102
13	72.7	98.1	109	120
14	84.3	114	126	139
16	110	149	165	181
18	139	188	208	230
20	172	232	257	283
22	208	281	311	343
24	248	334	370	408
26	291	392	435	479
28	337	455	504	555
30	387	523	579	638
32	440	594	658	725
36	557	752	833	918
40	688	929	1030	1130
44	832	1120	1240	1370
48	991	1340	1480	1630
52	1160	1570	1740	1920
56	1350	1820	2020	2220
60	1550	2090	2310	2550

\* Standard GB/T 20118, ISO 2408 is available upon request

# Rotation-resistant rope

## Compacted strand

### Application

Main hoist ropes for tower crane, crawler crane, mobile crane

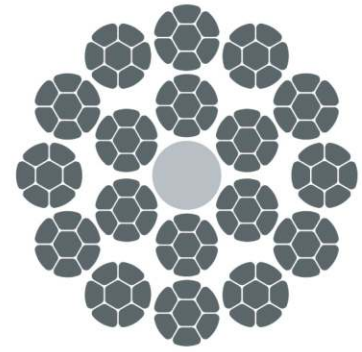

18×K7-FC

Rope $\varnothing$	Approx. length mass	MBL (1770)	MBL (1960)	MBL (2160)
mm	kg/100m	kN	kN	kN
6	15.4	22.3	24.7	27.2
7	20.9	30.4	33.6	37.0
8	27.3	39.6	43.9	48.4
9	34.6	50.2	55.6	61.2
10	42.7	62.0	68.6	75.6
11	51.7	75.0	83.0	91.5
12	61.5	89.2	98.8	109
13	72.2	105	116	128
14	83.7	121	134	148
16	109	159	176	194
18	138	201	222	245
20	171	248	274	302
22	207	300	332	366
24	246	357	395	435
26	289	419	464	511
28	335	486	538	593
30	384	558	617	680
32	437	634	702	774
36	553	803	889	980
40	683	991	1100	1210
44	827	1200	1330	1460
48	984	1430	1580	1740
52	1150	1680	1850	2040
56	1340	1940	2150	2370
60	1540	2230	2470	2720

\* Standard YB/T 5359, ISO 2408 is available upon request

# Rotation-resistant rope

## Compacted strand

### Application

Main hoist ropes for tower crane, crawler crane, mobile crane

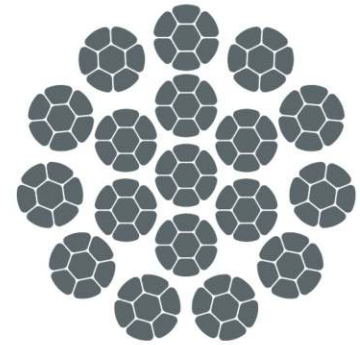

17×K7-WSC

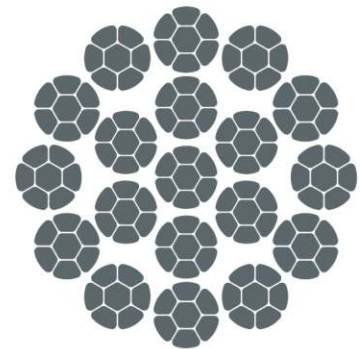

18×K7-WSC

Rope $\varnothing$	Approx. length mass	MBL (1770)	MBL (1960)	MBL (2160)
mm	kg/100m	kN	kN	kN
6	16.6	23.6	26.1	28.8
7	22.5	32.1	35.5	39.2
8	29.4	41.9	46.4	51.1
9	37.3	53.0	58.7	64.7
10	46.0	65.5	72.5	79.9
11	55.7	79.2	87.7	96.7
12	66.2	94.3	104	115
13	77.7	111	123	135
14	90.2	128	142	157
16	118	168	186	205
18	149	212	235	259
20	184	262	290	320
22	223	317	351	387
24	265	377	418	460
26	311	443	490	540
28	361	513	569	627
30	414	589	653	719
32	471	671	743	818
36	596	849	940	1040
40	736	1050	1160	1280
44	891	1270	1400	1550
48	1060	1510	1670	1840
52	1240	1770	1960	2160
56	1440	2050	2270	2510
60	1660	2360	2610	2880

\* Standard YB/T 5359, ISO 2408 is available upon request

# Rotation-resistant rope

## Compacted strand

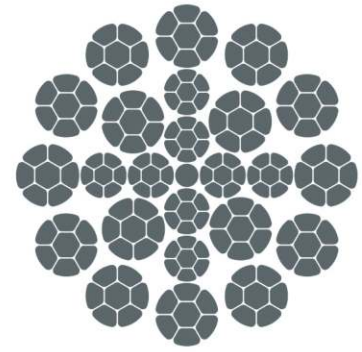

24(W)×K7

### Application

Main hoist ropes for tower crane, crawler crane, mobile crane

Rope $\varnothing$	Approx. length mass	MBL (1770)	MBL (1960)	MBL (2160)
mm	kg/100m	kN	kN	kN
12	70.6	105	116	128
13	82.8	123	136	150
14	96.0	142	158	174
15	110	163	181	199
16	125	186	206	227
17	142	210	232	256
18	159	235	260	287
19	177	262	290	320
20	196	290	321	354
22	237	351	389	429
24	282	418	463	510
26	331	491	543	599
28	384	569	630	694
30	441	653	723	797
32	502	743	823	907
34	566	839	929	1020
36	635	941	1040	1150
38	708	1050	1160	1280
40	784	1160	1290	1420
42	864	1280	1420	1560
44	949	1400	1560	1710
46	1040	1540	1700	1870
48	1130	1670	1850	2040
50	1230	1810	2010	2210
52	1320	1960	2170	2390
54	1430	2120	2340	2580
56	1540	2280	2520	2780
58	1650	2440	2700	2980
60	1760	2610	2890	3190

\* Standard YB/T 5359, ISO 2408 is available upon request

# Rotation-resistant rope

## Round strand

### Application

Main hoist ropes for tower crane, crawler crane, mobile crane

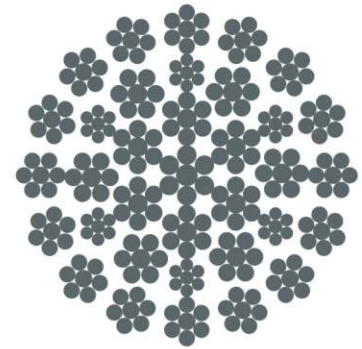

35(W)×7

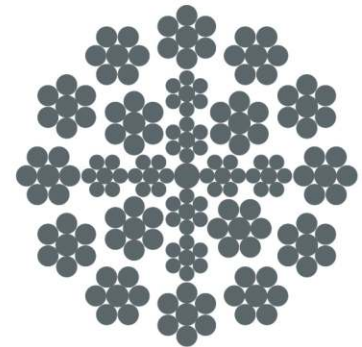

24(W)×7

Rope ø	Approx. length mass	MBL (1770)	MBL (1960)	MBL (2160)
mm	kg/100m	kN	kN	kN
10	46.0	63.7	70.6	75.6
11	55.7	77.1	85.4	91.5
12	66.2	91.8	102	109
13	77.7	108	119	128
14	90.2	125	138	148
16	118	163	181	194
18	149	206	229	245
20	184	255	282	302
22	223	308	342	366
24	265	367	406	435
26	311	431	477	511
28	361	500	553	593
30	414	573	635	680
32	471	652	723	774
36	596	826	914	980
40	736	1020	1130	1210
44	891	1230	1370	1460
48	1060	1470	1630	1740
52	1240	1720	1910	2040
56	1440	2000	2210	2370
60	1660	2290	2540	2720

\* Standard GB/T 20118, ISO 2408 is available upon request

# Rotation-resistant rope

## Compacted strand

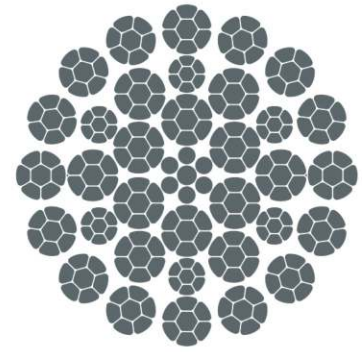

35(W)×K7

### Application

Main hoist ropes for tower crane, crawler crane, mobile crane

Rope ø	Approx. length mass	MBL (1770)	MBL (1960)	MBL (2160)
mm	kg/100m	kN	kN	kN
12	73.4	106	117	129
13	86.2	124	137	151
14	100	144	159	176
15	115	165	183	202
16	131	188	208	229
17	147	212	235	259
18	165	238	264	290
19	184	265	294	324
20	204	294	325	359
22	247	356	394	434
24	294	423	469	516
26	345	497	550	606
28	400	576	638	703
30	459	661	732	807
32	522	752	833	918
34	590	849	940	1040
36	661	952	1050	1160
38	736	1060	1170	1290
40	816	1180	1300	1430
42	900	1300	1430	1580
44	987	1420	1570	1740
46	1080	1550	1720	1900
48	1180	1690	1870	2070
50	1280	1840	2030	2240
52	1380	1990	2200	2420
54	1490	2140	2370	2610
56	1600	2300	2550	2810
58	1720	2470	2740	3020
60	1840	2640	2930	3230

\* Standard YB/T 5359, ISO 2408 is available upon request

# Rotation-resistant rope

## Compacted strand

### Application

Main hoist ropes for truck crane, tower crane, crawler crane, mobile crane

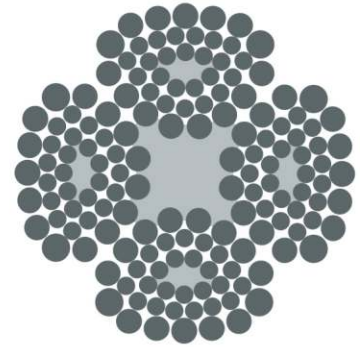

4×V39FC-FC

Rope $\varnothing$	Approx. length mass	MBL (1570)	MBL (1770)	MBL (1960)
mm	kg/100m	kN	kN	kN
10	41.0	56.5	63.7	70.6
11	49.6	68.4	77.1	85.4
12	59.0	81.4	91.8	102
13	69.3	95.5	108	119
14	80.4	111	125	138
16	105	145	163	181
18	133	183	206	229
20	164	226	255	282
22	198	274	308	342
24	236	326	367	406
26	277	382	431	477
28	321	443	500	553
30	369	509	573	635
32	420	579	652	723
34	474	653	737	816
36	531	732	826	914
38	592	816	920	1020
40	656	904	1020	1130

\* Standard GB/T 20118

# Standardized rope designation

These symbols have to be used for the standardized rope designation

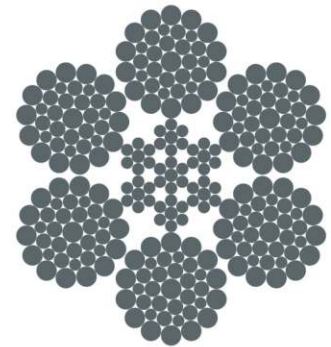

6×36WS-IWRC

## Example

10\_6 × 36 WS - IWRC 1770 U sZ GB/T 20118

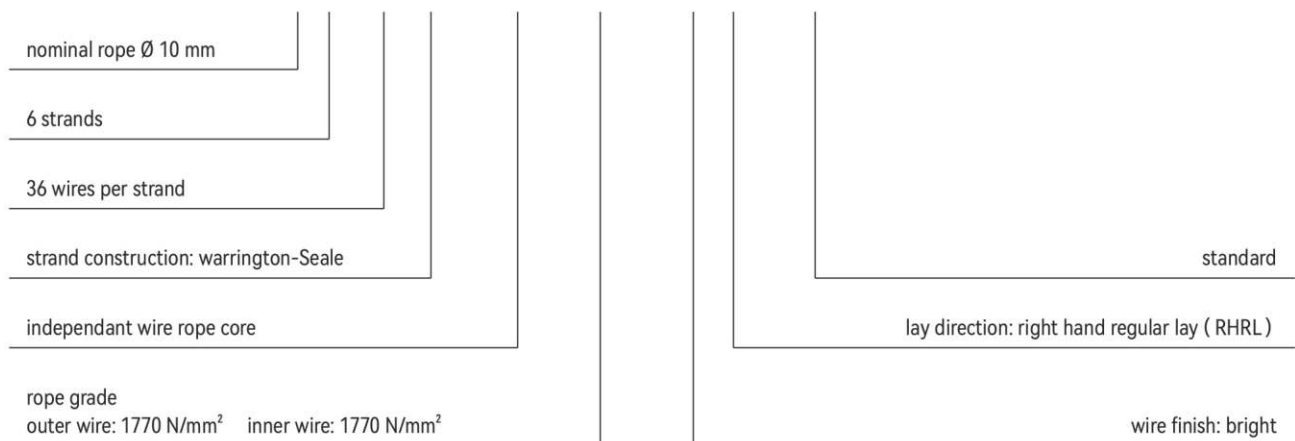

## Strand construction

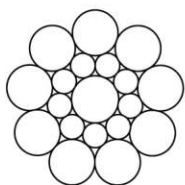

Seale

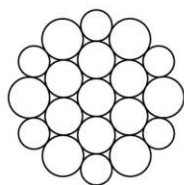

Warrington

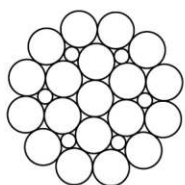

Filler

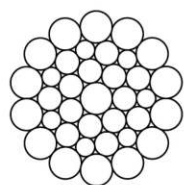

Warrington-Seale

## Lay direction

sZ = right hand regular lay  
zZ = right hand lang lay  
zS = left hand regular lay  
sS = left hand lang lay

## Wire finish

U = bright, non-galvanized  
B = quality B galvanized

## Rope core type

NFC = natural fibre core  
SFC = synthetic fiber core  
WSC = wire strand core  
IWRC = independant wire rope core  
PWRC = parallel wire rope centre

# Diameter measurement

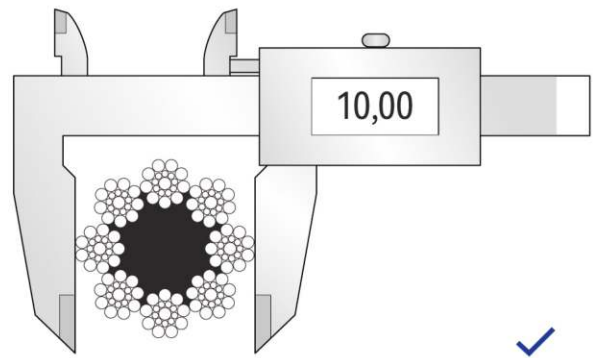
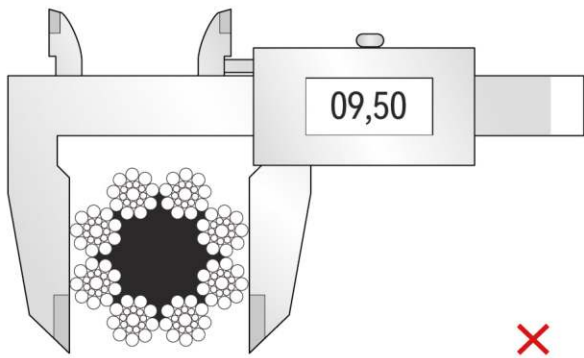

# Carrying ropes

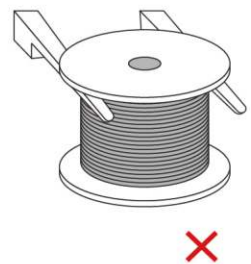
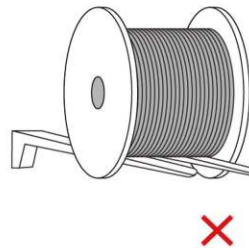
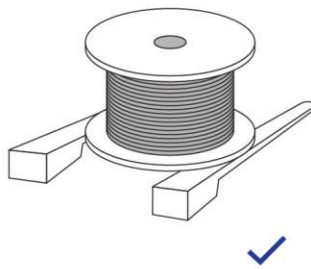
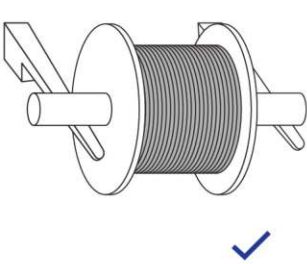

# Unwinding ropes

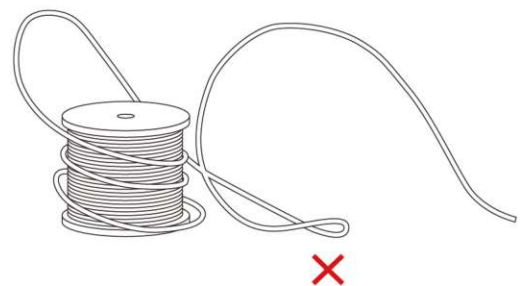
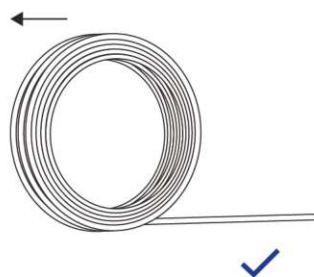
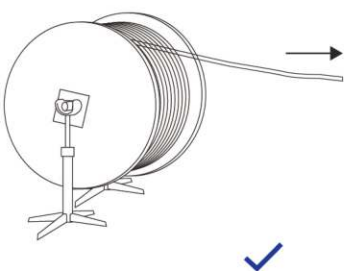



# CONTACT US

---

**WUXI METALLINK INTERNATIONAL TRADE CO.,LTD**

ADD No.99,Huichang Road, Huishan District, Wuxi, Jiangsu, China

EMAIL [arthur@wxmetallink.com](mailto:arthur@wxmetallink.com)

WEB [www.wxmetallink.com](http://www.wxmetallink.com)