



ELEVATOR ROPE

WUXI METALLINK

Contents

3 Traction ropes for low-rise elevator

8×19S-NFC
8×19W-NFC
8×25F-NFC

4 Traction ropes for mid-rise elevator

8×19S-IWRC
8×19W-IWRC
8×25F-IWRC
8×19S-CSC
8×19W-CSC
8×25F-CSC

6 Traction ropes for villa / MRL / hydraulic elevator

8×19S-IWRC
8×19W-IWRC
6×19W-WSC

7 Traction ropes for high-rise elevator

9×19S-IWRC
9×21F-IWRC
9×25F-IWRC
9×19S-CSC
9×21F-CSC
9×25F-CSC

9 Governor ropes

6×19S-SFC
8×19S-SFC

10 Compensating ropes

6×37M-SFC
6×29F-SFC
6×36WS-SFC

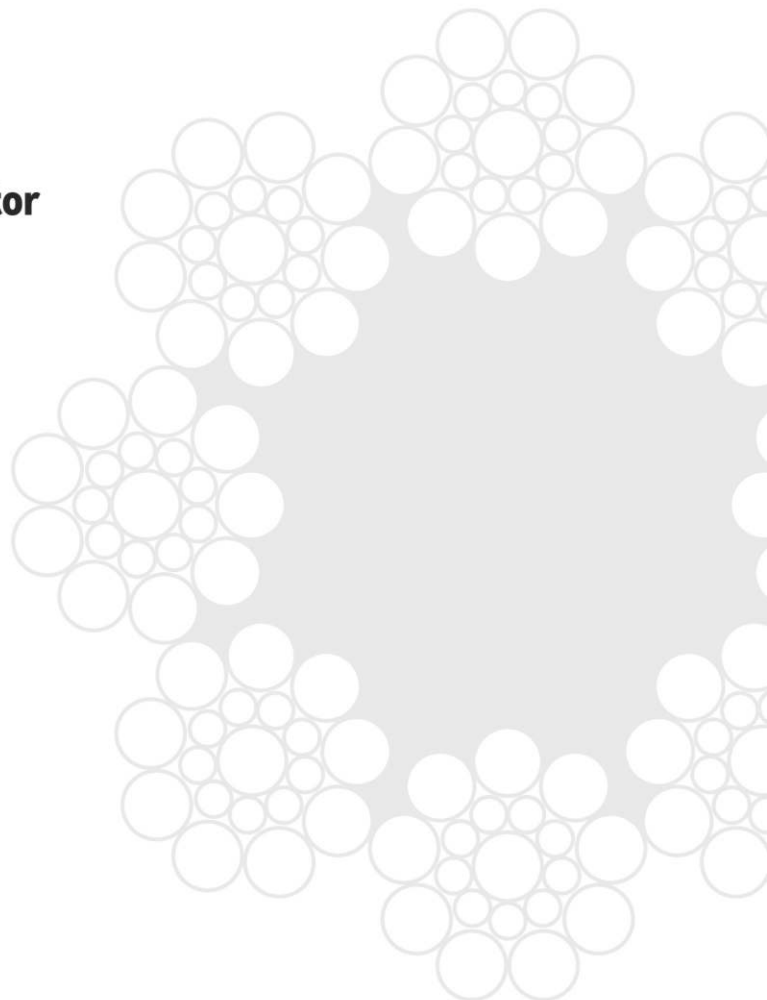

Fiber Core NFC (sisal)

8 Strands

Elevator traction ropes

For low-rise: lift speed $\leq 2.0\text{m/s}$, lifting height $\leq 80\text{m}$

For mid-rise: lift speed $\leq 3.0\text{m/s}$, lifting height $\leq 120\text{m}$

Rope \varnothing		Approx. length mass	MBL (1370/1770)	MBL (1570/1770)	MBL (1570)
mm	inch	kg/100m	kN	kN	kN
6		12.4	15.8	17.3	16.6
6.35	1/4	13.9	17.7	19.4	18.5
6.5		14.6	18.6	20.3	19.4
8	5/16	22.1	28.1	30.8	29.4
9		27.9	35.6	38.9	37.3
9.5		31.1	39.7	43.4	41.5
10	3/8	34.5	44.0	48.1	46.0
11	7/16	41.7	53.2	58.1	55.7
12		49.7	63.3	69.2	66.2
12.7	1/2	55.6	70.9	77.5	74.2
13		58.3	74.3	81.2	77.7
14		67.6	86.1	94.2	90.2
14.3	9/16	70.5	89.9	98.3	94.1
15.9	5/8	87.2	111	121	116
16		88.3	113	123	118

* Standard ISO 4344, EN 12385-5 is available upon request

* For diameter $< 8\text{mm}$, polymer core or SFC instead of sisal core

Rope \varnothing		Approx. length mass	MBL (Grade E)	MBL (Grade A)
mm	kg/100m	kN	kN	
8	22.0	26.0	30.8	
10	34.3	40.6	48.1	
11	41.5	49.2	58.2	
12	49.4	58.5	69.2	
13	57.9	68.6	81.3	
14	67.2	79.6	94.3	
16	87.8	104	123	

* Standard JISG 3525

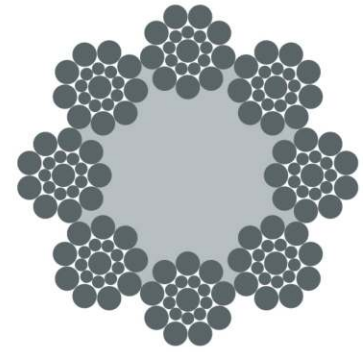

8×19S-NFC

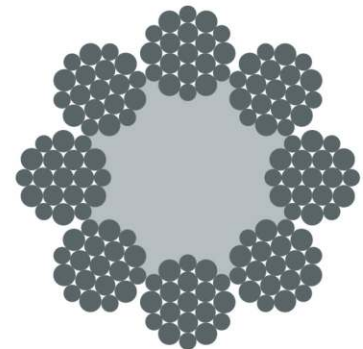

8×19W-NFC

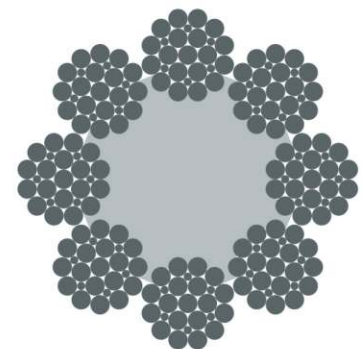

8×25F-NFC

Full Steel Core IWRC

8 Strands

Elevator traction ropes

For mid-rise: lift speed $\leq 4.0\text{m/s}$, lifting height $\leq 200\text{m}$

Rope \varnothing		Approx. length mass	MBL (1370/1770)	MBL (1570/1770)	MBL (1570)
mm	inch	kg/100m	kN	kN	kN
8	5/16	26.4	38.4	40.8	38.4
9		33.4	48.6	51.7	48.6
9.5	3/8	37.2	54.1	57.6	54.1
10		41.2	60.0	63.8	60.0
11	7/16	49.9	72.6	77.2	72.6
12		59.3	86.4	91.9	86.4
12.7	1/2	66.5	96.7	103	96.7
13		69.6	101	108	101
14.3	9/16	84.2	123	130	123
15		92.7	135	144	135
15.9	5/8	104	152	161	152
16		105	154	163	154

* Standard ISO 4344, EN 12385-5 is available upon request

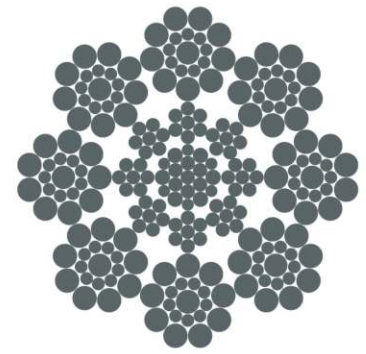

8×19S-IWRC

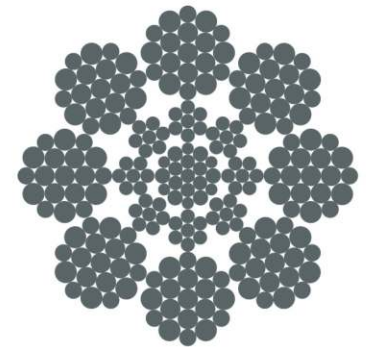

8×19W-IWRC

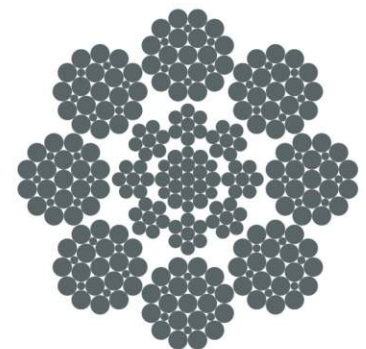

8×25F-IWRC

Composite Steel Core CSC 8 Strands

Elevator traction ropes

For mid-rise: lift speed $\leq 4.0\text{m/s}$, lifting height $\leq 200\text{m}$

Rope \varnothing		Approx. length mass	MBL (1370/1770)	MBL (1570/1770)	MBL (1570)
mm	inch	kg/100m	kN	kN	kN
8	5/16	24.2	35.4	37.6	35.4
9		30.6	44.8	47.6	44.8
9.5	3/8	34.1	49.9	53.1	49.9
10		37.8	55.3	58.8	55.3
11	7/16	45.7	66.9	71.1	66.9
12		54.4	79.6	84.6	79.6
12.7	1/2	61.0	89.1	94.8	89.1
13		63.9	93.4	99.3	93.4
14.3	9/16	77.3	113	120	113
15		85.1	124	132	124
15.9	5/8	95.6	139	148	139
16		96.8	141	150	141

* Standard ISO 4344

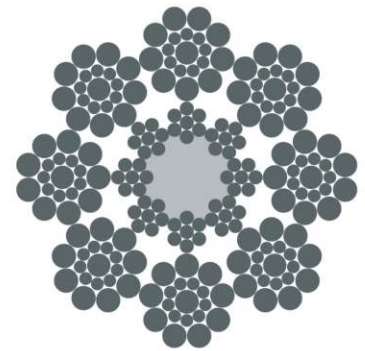

8×19S-CSC

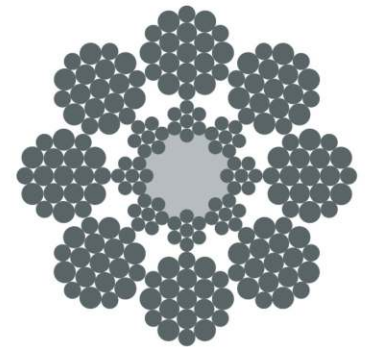

8×19W-CSC

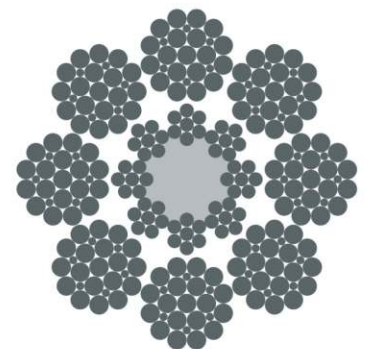

8×25F-CSC

Full Steel Core IWRC (7x7) 8 Strands

Elevator traction ropes

For villa / MRL / hydraulic elevator

Rope \varnothing		Approx. length mass	MBL (1570)	MBL (1770)	MBL (1770)
mm	inch	kg/100m	kN	kN	kN
6		14.8	21.6	24.3	25.9 [†]
6.35	1/4	16.6	24.2	27.3	---
6.5		17.4	25.3	28.6	31.5 [†]

* Standard ISO 4344, EN 12385-5 is available upon request

* [1] High performance

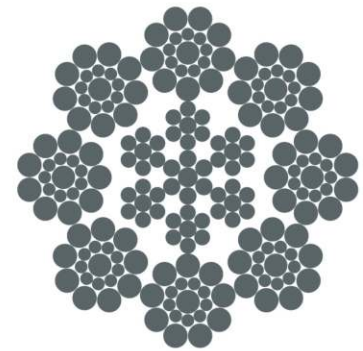

8×19S-IWRC

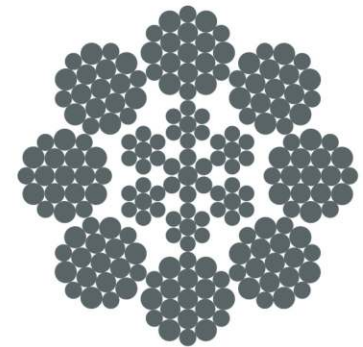

8×19W-IWRC

Full Steel Core WSC 6 Strands

Elevator traction ropes

For villa / MRL / hydraulic elevators

Rope \varnothing		Approx. length mass	MBL (1770)
mm	inch	kg/100m	kN
6		15.0	22.7
6.35	1/4	16.9	25.4
6.5		17.7	26.6

* Standard ISO 4344

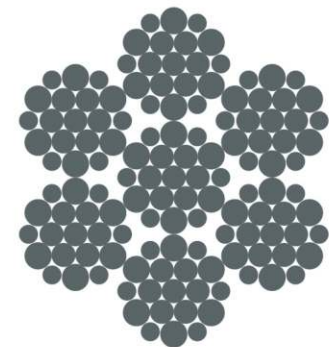

6×19W-WSC

Full Steel Core IWRC

9 Strands

Elevator traction ropes

For mid-rise: lift speed $\geq 4.0\text{m/s}$, lifting height $\leq 300\text{m}$

Rope \varnothing		Approx. length mass	MBL (1570/1770)	MBL (1570)	MBL (1770)
mm	inch	kg/100m	kN	kN	kN
8	5/16	27.0	41.5	39.0	44.0
9		34.2	52.5	49.3	55.6
9.5	3/8	38.1	58.5	55.0	62.0
10		42.2	64.8	60.9	68.7
11	7/16	51.1	78.4	73.7	83.1
12		60.8	93.3	87.7	98.9
12.7	1/2	68.1	105	98.3	111
13		71.3	110	103	116
14		82.7	127	119	135
14.3	9/16	86.3	133	125	140
15.9	5/8	107	164	154	174
16		108	166	156	176
18		137	210	197	223

* Standard ISO 4344

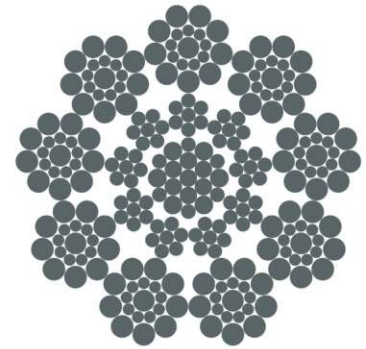

9×19S-IWRC

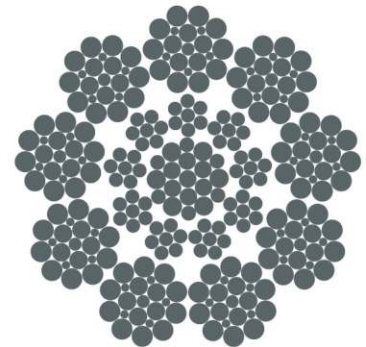

9×21F-IWRC

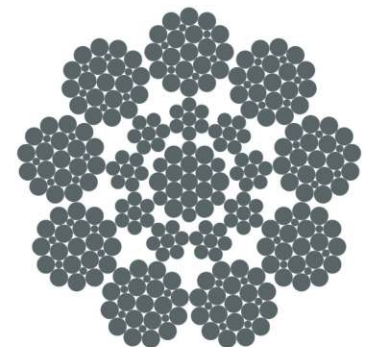

9×25F-IWRC

Composite Steel Core 9 Strands

Elevator traction ropes

For mid-rise: lift speed $\geq 4.0\text{m/s}$, lifting height $\leq 300\text{m}$

Rope \varnothing		Approx. length mass	MBL (1570/1770)	MBL (1570)	MBL (1770)
mm	inch	kg/100m	kN	kN	kN
8	5/16	23.7	36.9	34.7	39.1
9		30.1	46.7	43.9	49.5
9.5	3/8	33.5	52.0	48.9	55.1
10		37.1	57.6	54.2	61.1
11	7/16	44.9	69.7	65.5	73.9
12		53.4	83.0	78.0	87.9
12.7	1/2	59.8	93	87.4	98
13		62.7	97	92	103
14		72.7	113	106	120
14.3	9/16	75.9	118	111	125
15.9	5/8	94	146	137	154
16		95	147	139	156
18		120	187	175	198

* Standard ISO 4344

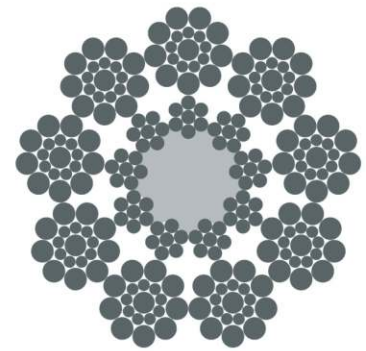

9×19S-CSC

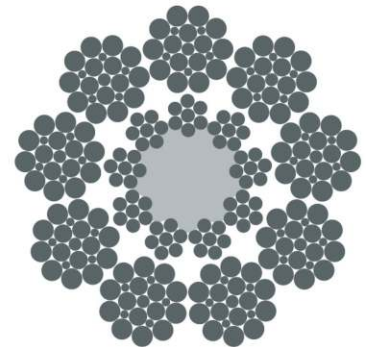

9×21F-CSC

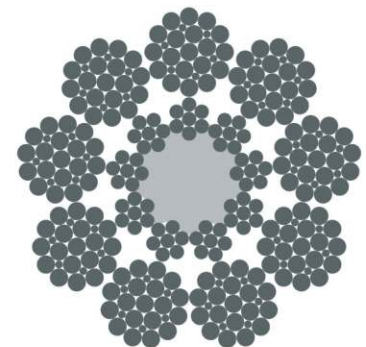

9×25F-CSC

Fiber Core SFC (pp)

6 Strands

Elevator governor ropes

Rope \varnothing		Approx. length mass	MBL (1370/1770)	MBL (1770)
mm	inch	kg/100m	kN	kN
6		12.9	17.8	21.0
6.35	1/4	14.5	20.0	23.6
6.5		15.2	20.9	24.7
8		23.0	31.7	37.4

* Standard ISO 4344, EN 12385-5 is available upon request

Rope \varnothing		Weight	MBL (Grade E)
mm		kg/100m	kN
6		13.9	16.1
6.3		15.3	17.8
8		24.7	28.6

* Standard JIS G3525

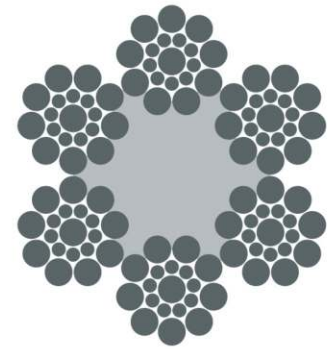

6x19S-SFC

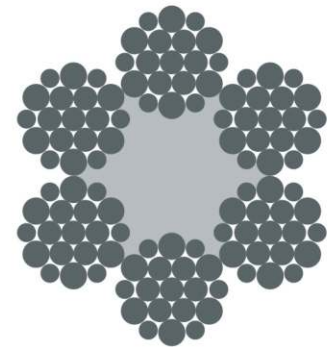

6x19W-SFC

Fiber Core SFC (pp)

8 Strands

Elevator governor ropes

Rope \varnothing		Approx. length mass	MBL (1370/1770)
mm	inch	kg/100m	kN
8	5/16	22.1	28.1
10		34.5	44.0
12		49.7	63.3

* Standard ISO 4344

* EN 12385-5 is available upon request

Rope \varnothing		Approx. length mass	MBL (Grade E)
mm		kg/100m	kN
8		22.0	26.0
10		34.3	40.6
12		49.4	58.5

* Standard JIS G3525

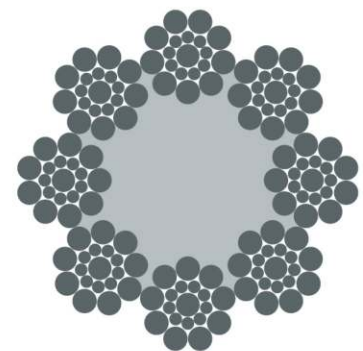

8x19S-SFC

Fiber Core SFC (pp)

6 Strands

Elevator compensating ropes

Rope \varnothing		Approx. length mass	MBL (1570)	MBL (1770)
mm	inch	kg/100m	kN	kN
16		88.6	119	134
18		112	150	169
20		138	185	209
22		167	224	253
24		199	267	301
26		234	313	353
28		271	363	409

* Standard ISO 4344

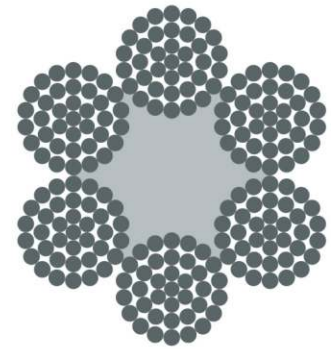

6x37M-SFC

Fiber Core SFC (pp)

6 Strands

Elevator compensating ropes

Rope \varnothing		Approx. length mass	MBL (1570)	MBL (1770)	MBL (1960)
mm	inch	kg/100m	kN	kN	kN
13		63.8	89.7	101	112
14		74.0	104	117	130
16		96.7	136	153	169
18		122	172	193	214
19		136	191	216	239
20		151	212	239	265
22		183	256	289	320
24		217	305	344	381
26		255	358	404	448
28		296	416	469	519

* Standard ISO 4344

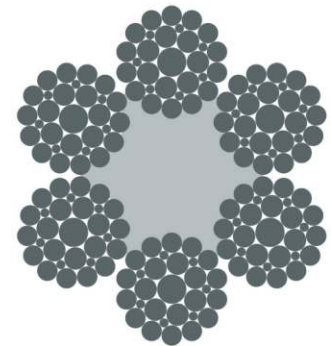

6x29F-SFC

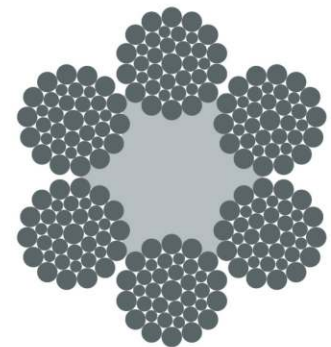

6x36WS-SFC

Standardized rope designation

These symbols have to be used for the standardized rope designation

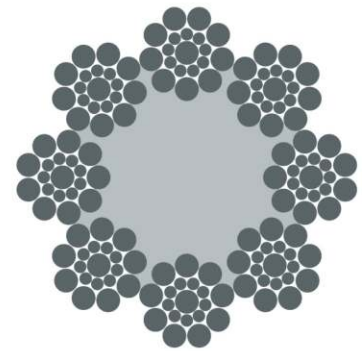

8×19S-NFC

Example

10₈ × 19 S - NFC 1370/1770 U sZ ISO4344

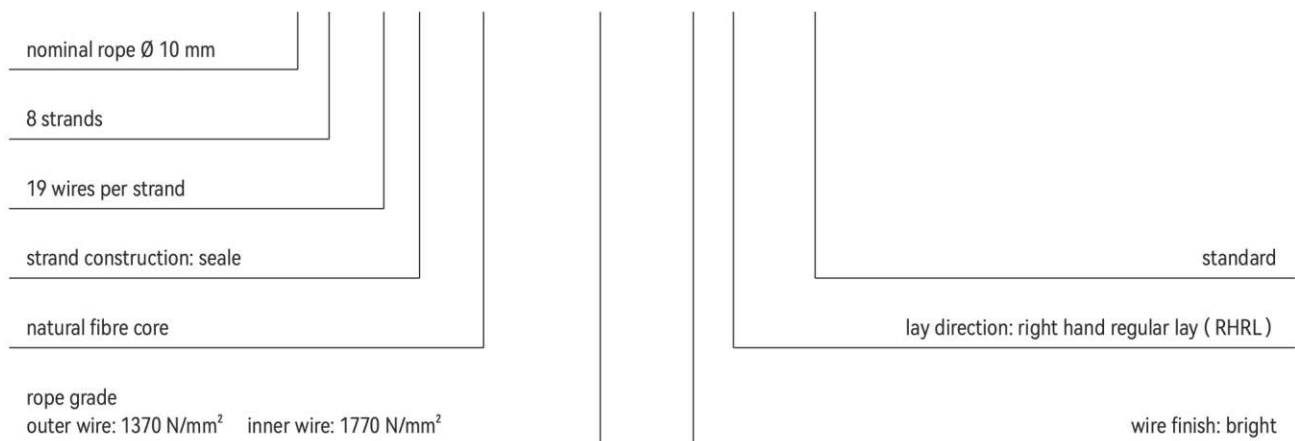

Strand construction

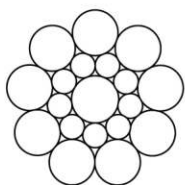

Seale

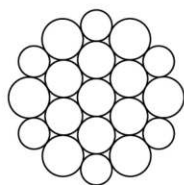

Warrington

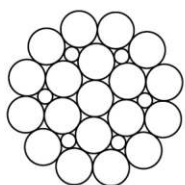

Filler

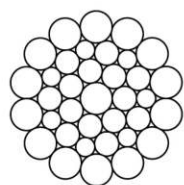

Warrington-Seale

Wire finish

U = bright, non-galvanized
B = quality B galvanized

Lay direction

sZ = right hand regular lay
zZ = right hand lang lay
zS = left hand regular lay
sS = left hand lang lay

Rope core type

NFC = natural fibre core
SFC = synthetic fiber core
WSC = wire strand core
IWRC = independant wire rope core
PWRC = parallel wire rope centre

Rope grade - hardness

Rope grade of outer wire	Hardness of unhardened traction sheave
N/mm ²	HB
1180	180 - 200
1370	200 - 230
1570	220 - 240
1620	230 - 250
1770	240 - 260

* Standard ISO 18265

Diameter measurement

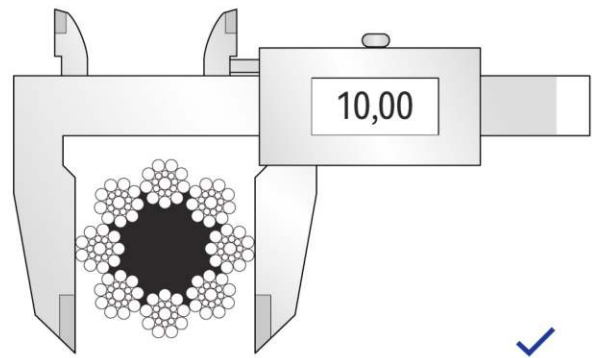
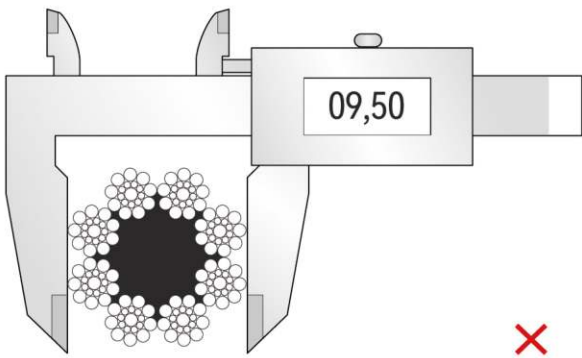

Carrying ropes

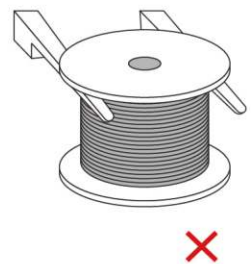
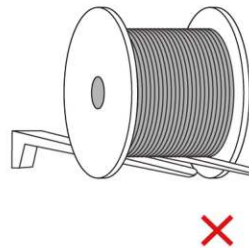
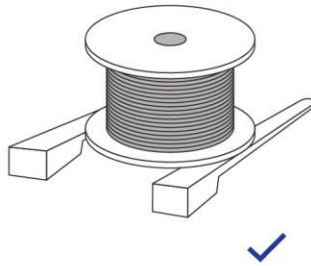
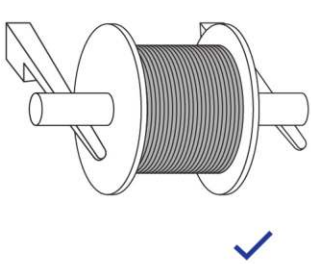

Unwinding ropes

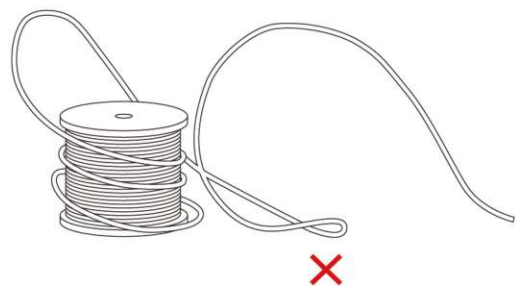
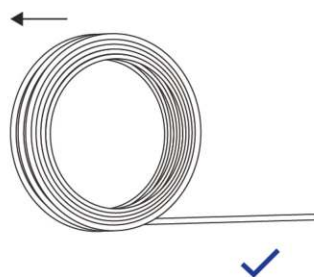
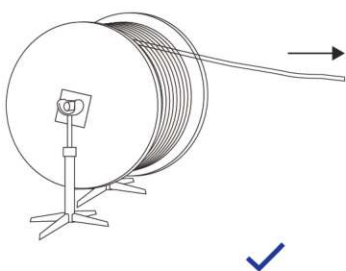

CONTACT US

WUXI METALLINK INTERNATIONAL TRADE CO.,LTD
JIANGSU METALLINK METAL PRODUCTS CO., LTD

ADD No.99,Huichang Road, Huishan District, Wuxi, Jiangsu, China
EMAIL arthur@wxmetallink.com
WEB www.wxmetallink.com